

Technical data sheet

Nominal capacity (based on suction conditions 1 bar (a), 20°C)	Unit	Design data
Volume flow inlet	m³/h	340
Volume flow outlet	m³/h	340
Compressed air inlet temperature	°C	35
Working pressure	bar g	7
Residual oil content	mg/m³	< 0,003

General data	Unit	Design data
Maximum operating pressure	bar g	16
Minimum operating pressure	bar g	0
Maximum inlet temperature	°C	50°C (25° eff.)
Ambient temperature minimum	°C	2

Norms and key figures	Unit	Design data
Pressure vessel standard		2014/68/EU
Category		III
Module	Type	B+F
Fluid group		2
Testing pressure	bar g	24

Scope of supply	Unit	Design data
Ready-to-operate adsorption dryer	Type	ATCN 34
Afterfilter	Type	APF133DMF
Filling	Type	Activated carbon dedusted
Total weight of filling	Kg	33
Oil indicator A4000		yes

Options	Unit	Design data
Preliminary filter	Type	APF133SMA

Technical data sheet

Dimensions and weights	Unit	Design data
A	mm	1542
B (in)	mm	1466
B (out)	mm	1047
C	mm	650
D	mm	700
Nominal size inside the adsorber	Inch	1 1/2"
Connection input	Inch	1 1/2"
Output connection	Inch	1 1/2"
Total weight	Kg	166
Vessel volume	Liter	66

Dimensional drawings

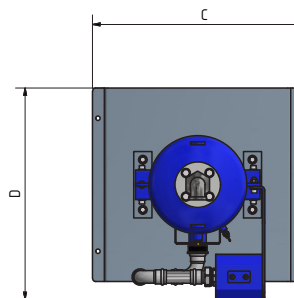
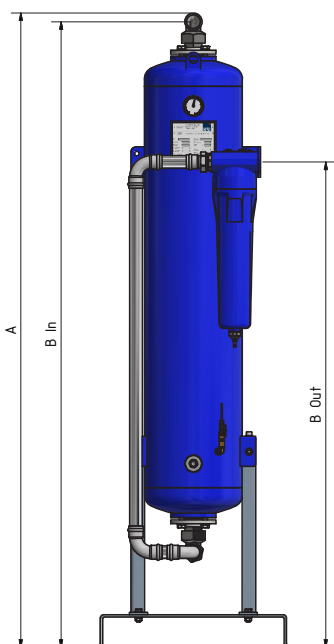

Correction factors

Inlet temperature

°C	< 25	25	30	35	38	40	45	48	50
F(t)	1,2	1,1	1,09	1	0,84	0,78	0,72	0,65	0,58

Correction factors working pressure

bar g	4	4,5	5	5,5	6	6,5	7	7,5	8	8,5	9	9,5	10	10,5	11	11,5	12	12,5	13	13,5	14	14,5	15	15,5	16
F(p)	0,6	0,7	0,74	0,82	0,89	0,97	1	1,08	1,11	1,16	1,22	1,29	1,36	1,42	1,5	1,57	1,63	1,69	1,75	1,83	1,9	1,96	2,03	2,1	2,14

Please multiply the capacity with the correction factors in the above table