

Activated carbon adsorber ATC-APN 1

Rev 01_0224

Technical data sheet

Page 1 of 2

Nominal capacity (based on suction conditions 1 bar (a), 20°C)	Unit	Design data
Volume flow inlet	m ³ /h	5
Volume flow outlet	m ³ /h	5
Compressed air inlet temperature	°C	35
Working pressure	bar g	7
Residual oil content	mg/m ³	< 0,003

General data	Unit	Design data
Maximum operating pressure	bar g	16
Minimum operating pressure	bar g	0
Maximum inlet temperature	°C	50°C (25° eff.)
Ambient temperature minimum	°C	2

Norms and key figures	Unit	Design data
Pressure vessel standard		abnahmefrei nach 2014/68/EU
Category		Art. 4 (3)
Module	Type	-
Fluid group		2
Testing pressure	bar g	24

Scope of supply	Unit	Design data
Ready-to-operate adsorption dryer	Type	ATC-APN 1
Afterfilter	Type	APF53DMF
Filling	Type	Activated carbon dedusted
Total weight of filling	Kg	0,69
Oil indicator A-4000-120		no

Options	Unit	Design data
Preliminary filter	Type	APF53SMA

Activated carbon adsorber ATC-APN 1

Rev 01_0224

Technical data sheet

Dimensions and weights	Unit	Design data
A	mm	594
B	mm	535
C	mm	235
D	mm	180
Nominal size inside the adsorber	Inch	3/8"
Connection input	Inch	1/4"
Output connection	Inch	3/8"
Total weight	Kg	7
Vessel volume	Liter	1,38

Dimensional drawings

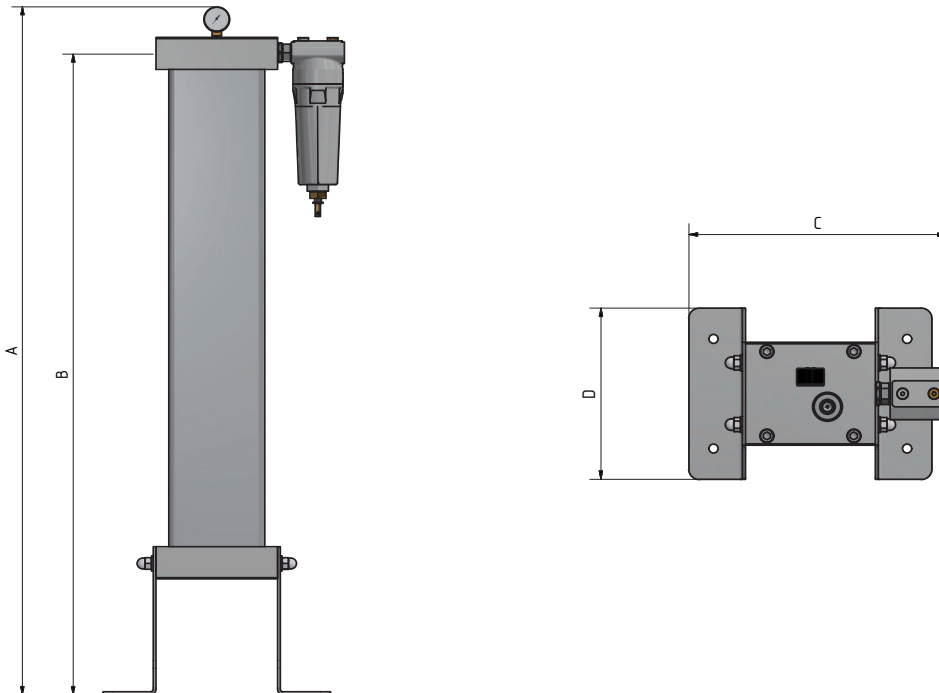

Correction factors									
Inlet temperature									
°C	< 25	25	30	35	38	40	45	48	50
F(t)	1,2	1,1	1,09	1	0,84	0,78	0,72	0,65	0,58

Correction factors working pressure																									
bar g	4	4,5	5	5,5	6	6,5	7	7,5	8	8,5	9	9,5	10	10,5	11	11,5	12	12,5	13	13,5	14	14,5	15	15,5	16
F(p)	0,6	0,7	0,74	0,82	0,89	0,97	1	1,08	1,11	1,16	1,22	1,29	1,36	1,42	1,5	1,57	1,63	1,69	1,75	1,83	1,9	1,96	2,03	2,1	2,14

Please multiply the capacity with the correction factors in the above table